

SEATING OVERVIEW / COPENHAGUE TABLE

The table drawings below are shown with About A Chair with arm (width 59 cm).

CPH10 / L160 X D80 CM

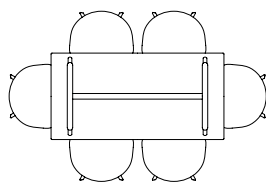

CPH20 / Ø90 CM

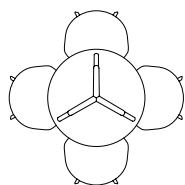

CPH20 / Ø120 CM

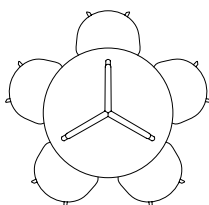

CPH25 / Ø140 CM

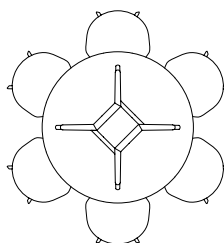

CPH30 / L200 X W90 CM

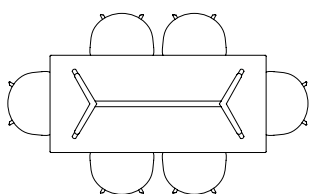

CPH30 / L250 X W90 CM

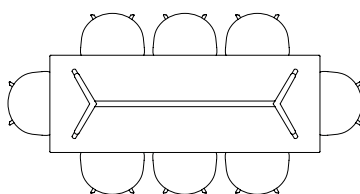

CPH30 / L300 X W90 CM

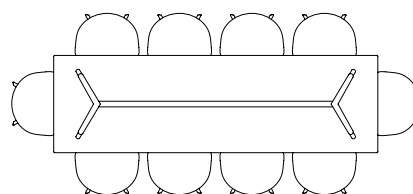

CPH30 / L250 X W120 CM

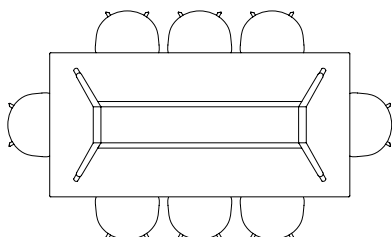

CPH30 / L300 X W120 CM

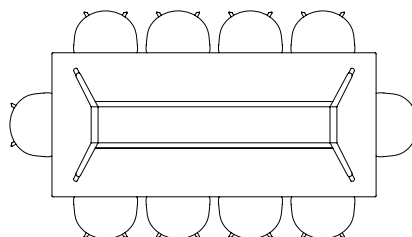

SEATING OVERVIEW / COPENHAGUE DEUX TABLE

The table drawings below are shown with About A Chair with arm (width 59 cm).

CPH DEUX 220 / Ø75 CM

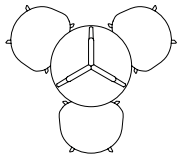

CPH DEUX 220 / Ø98 CM

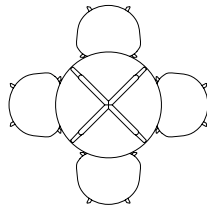

CPH DEUX 210 / L75 X W75 CM

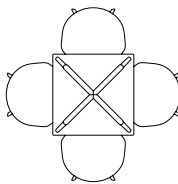

CPH DEUX 210 / L140 X W75 CM

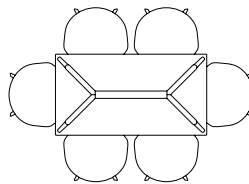

CPH DEUX 210 / L200 X W75 CM

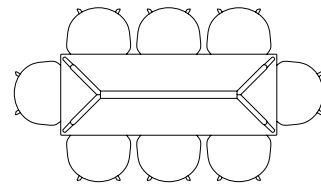

SEATING OVERVIEW / CPH30 EXTENDABLE TABLE

The table drawings below are shown with About A Chair with arm (width 59 cm).

CPH30 EXTENDABLE / L160 X W80 CM

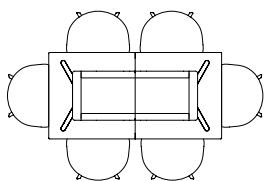

INCL. 1 X TABLE LEAF / L210 CM

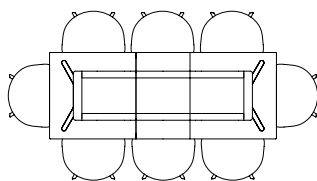

INCL. 2 X TABLE LEAVES / L260 CM

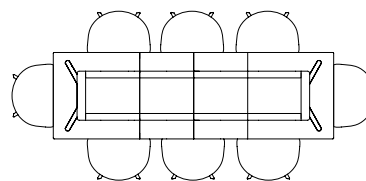

INCL. 3 X TABLE LEAVES / L310 CM

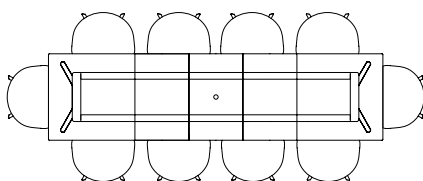

CPH30 EXTENDABLE / L200 X W90 CM

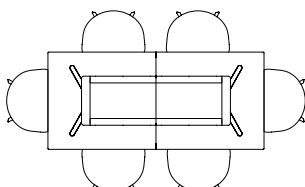

INCL. 1 X TABLE LEAF / L250 CM

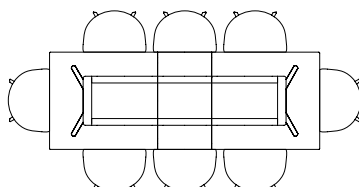

INCL. 2 X TABLE LEAVES / L300 CM

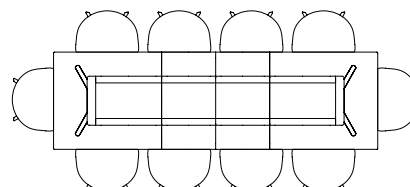

INCL. 3 X TABLE LEAVES / L350 CM

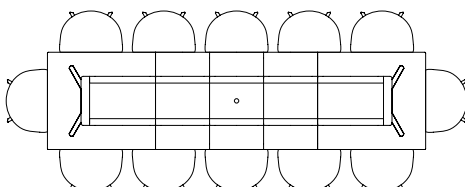

INCL. 4 X TABLE LEAVES / L400 CM

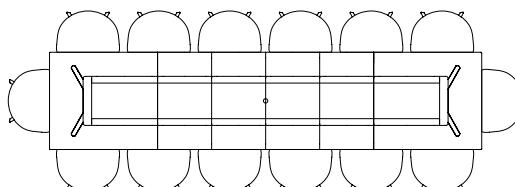

CPH30 EXTENDABLE / L250 X W90 CM

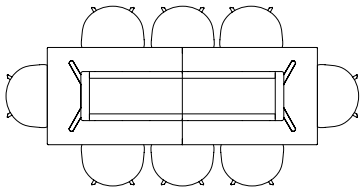

INCL. 1 X TABLE LEAVES / L300 CM

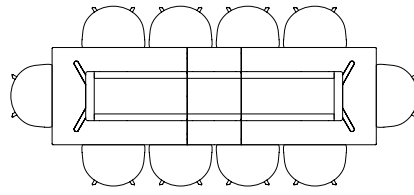

INCL. 2 X TABLE LEAVES / L350 CM

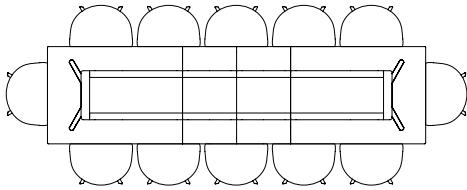

INCL. 3 X TABLE LEAVES / L400 CM

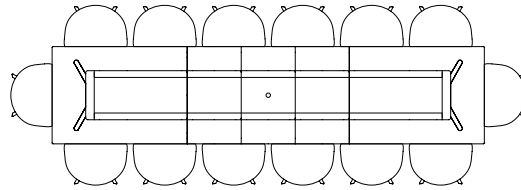

INCL. 4 X TABLE LEAVES / L450 CM

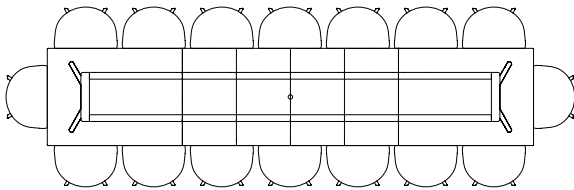

SEATING OVERVIEW / ABOUT A TABLE

The table drawings below are shown with About A Chair with arm (width 59 cm).

AAT15 / L80 X W80 CM

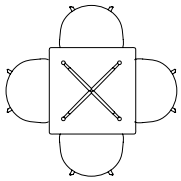

AAT10 / L160 X W80 CM

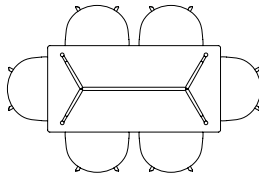

AAT10 / L180 X W90 CM

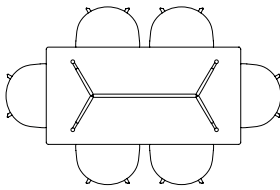

AAT10 / L220 X W90 CM

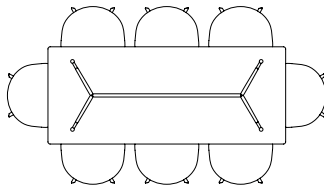

AAT10 / L280 X W90 CM

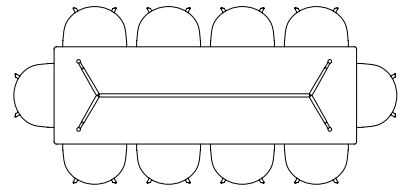

AAT10 / L180 X W105 CM

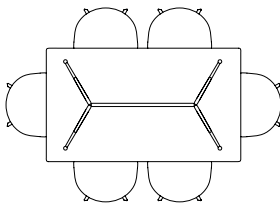

AAT10 / L220 X W105 CM

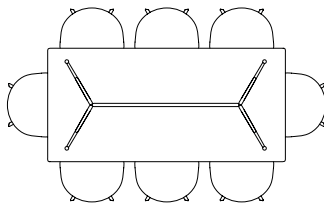

AAT10 / L280 X W105 CM

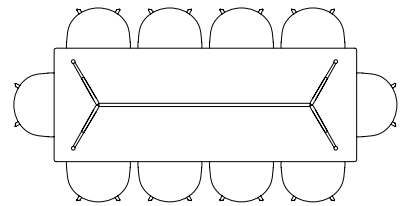

AAT20 / Ø80 CM

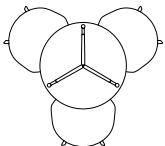

AAT20 / Ø100 CM

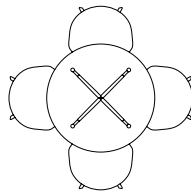

AAT20 / Ø110 CM

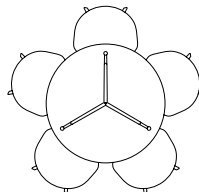

AAT20 / Ø128 CM

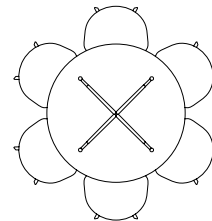

SEATING OVERVIEW / T12 TABLE

The table drawings below are shown with About A Chair with arm (width 59 cm).

T12 / L160 X W80 CM

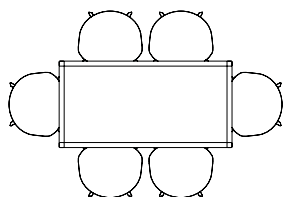

T12 / L200 X W95 CM

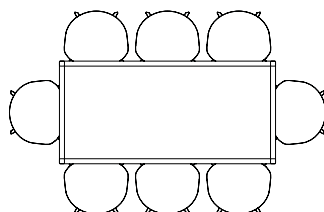

T12 / L250 X W95 CM

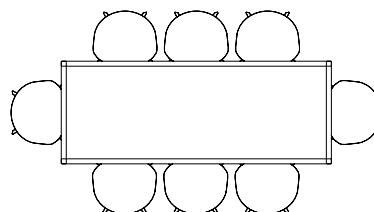

T12 / L320 X W95 CM

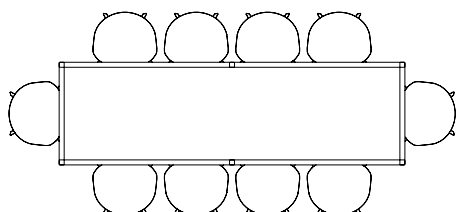

T12 / L400 X W95 CM

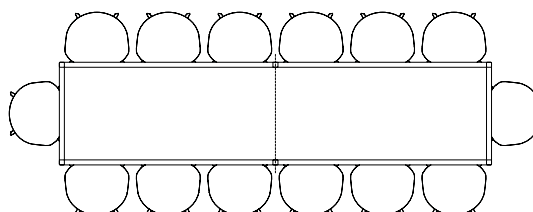

T12 / L200 X W120 CM

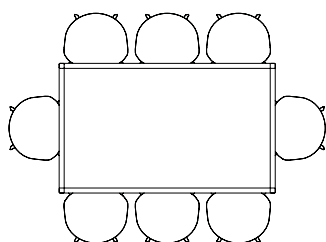

T12 / L250 X W120 CM

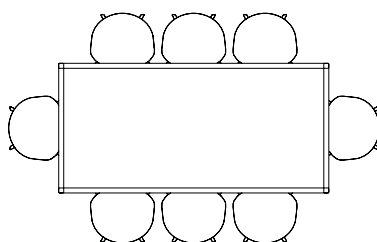

T12 / L320 X W120 CM

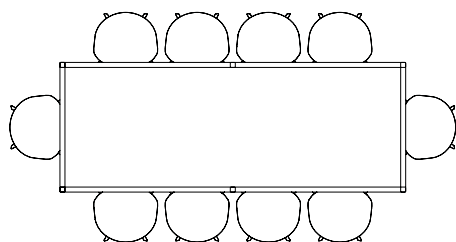

T12 / L400 X W120 CM

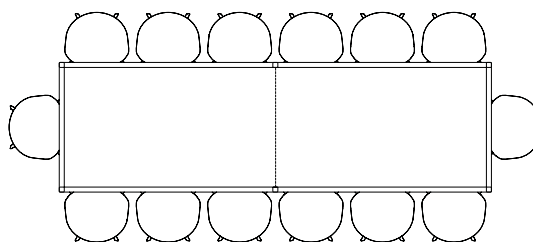

SEATING OVERVIEW / LOOP STAND TABLE

The table drawings below are shown with About A Chair with arm (width 59 cm).

LOOP STAND TABLE / L160 X W77,5 CM

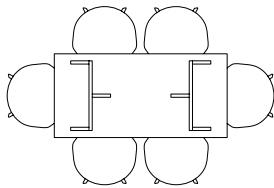

LOOP STAND TABLE / L180 X W87,5 CM

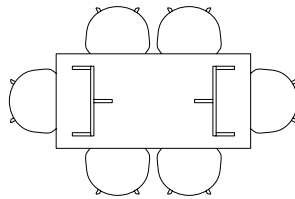

LOOP STAND TABLE / L200 X W92,5 CM

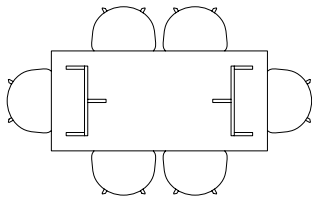

LOOP STAND TABLE / L250 X W92,5 CM

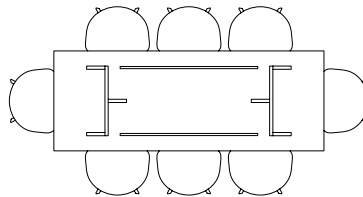

LOOP STAND ROUND / Ø105 CM

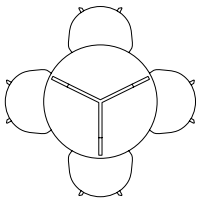

LOOP STAND ROUND / Ø120 CM

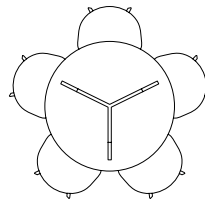

SEATING OVERVIEW / PYRAMID TABLE

The table drawings below are shown with About A Chair with arm (width 59 cm).

PYRAMID CAFÉ TABLE 21 / Ø70 CM

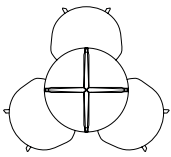

PYRAMID CAFÉ TABLE 21 / L70 X W70 CM

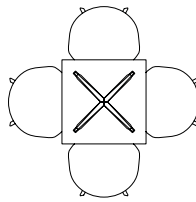

PYRAMID TABLE 01 / L140 X W65 CM

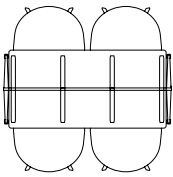

PYRAMID TABLE 21 / L140 X W75 CM

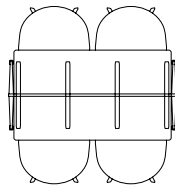

PYRAMID TABLE 21 / L200 X W75 CM

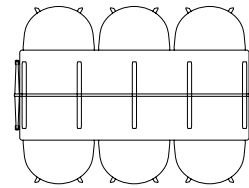

PYRAMID TABLE 02 / L190 X W85 CM

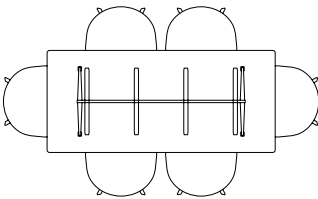

PYRAMID TABLE 02 / L250 X W85 CM

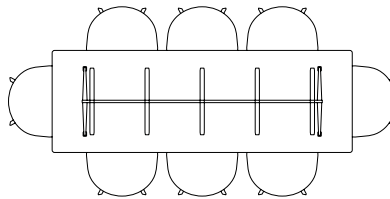

PYRAMID TABLE 02 / L300 X W85 CM

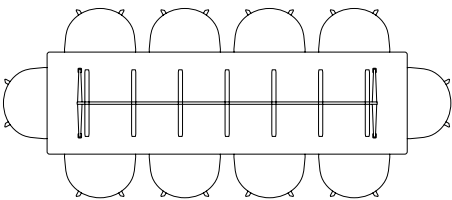

SEATING OVERVIEW / PYRAMID TABLE

The table drawings below are shown with Pyramid Benches of various lengths
(85 cm / 140 cm / 200 cm / 190 cm / 250 cm X 40 cm).

L140 X W65 CM WITH BENCH L140 & L85 CM

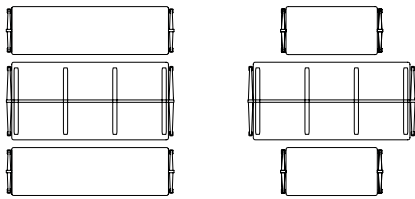

L140 X W75 CM WITH BENCH L140 & L85 CM

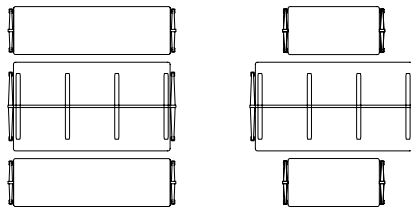

L200 X W75 CM WITH BENCH L200, L140 & L190 CM

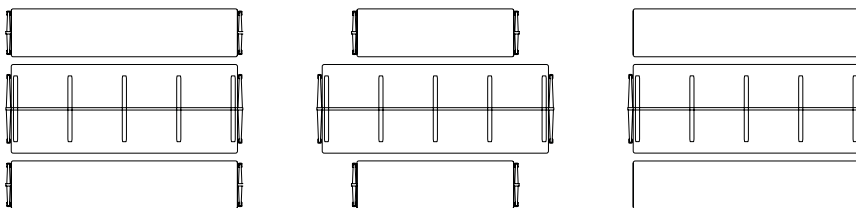

L190 X W85 CM WITH BENCH L190, L140 & L85 CM

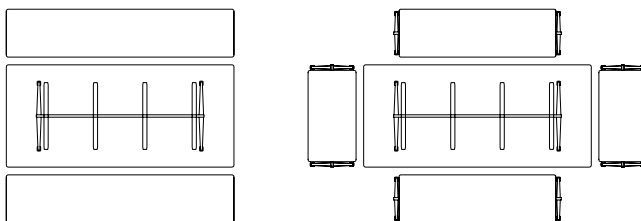

L250 X W85 CM WITH BENCH L250 & L200 CM

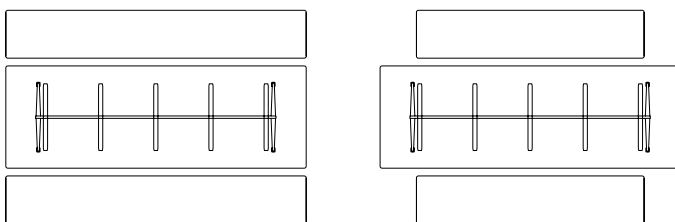

L300 X W85 CM WITH BENCH L250 & L85 CM

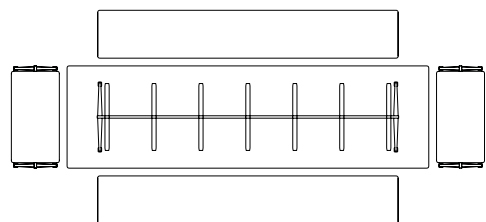

SEATING OVERVIEW / TRIANGLE LEG TABLE

The table drawings below are shown with About A Chair with arm (width 59 cm).

TRIANGLE LEG TABLE / Ø115 CM

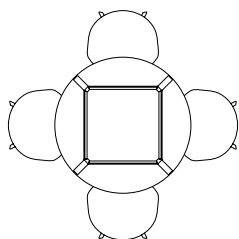

TRIANGLE LEG TABLE / L200 X W85 CM

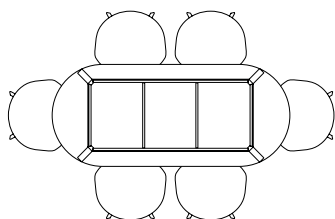

TRIANGLE LEG TABLE / L250 X W85 CM

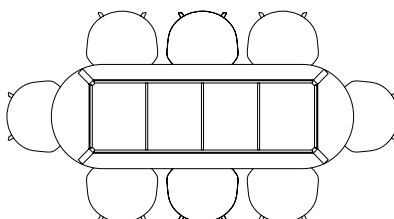

TRIANGLE LEG TABLE / L200 X W85 CM

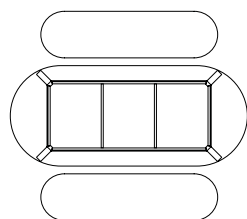

TRIANGLE LEG TABLE / L250 X W85 CM

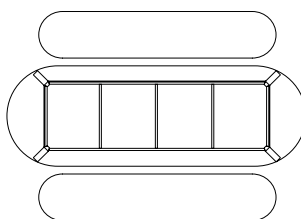

SEATING OVERVIEW / PALISSADE CONE TABLE

The table drawings below are shown with About A Chair with arm (width 59 cm)

PALISSADE CONE TABLE / L65 X W65 CM

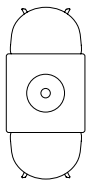

PALISSADE CONE TABLE / Ø70 CM

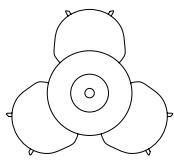

PALISSADE CONE TABLE / Ø90 CM

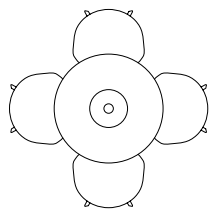

SEATING OVERVIEW / TERRAZZO TABLE

The table drawings below are shown with About A Chair with arm (width 59 cm)

TERRAZZO TABLE / L60 X W60CM

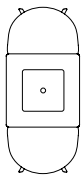

TERRAZZO TABLE / Ø70 CM

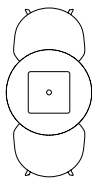

SEATING OVERVIEW / NEU TABLE

The table drawings below are shown with About A Chair with arm (width 59 cm)

NEU TABLE / L60 X W60 CM

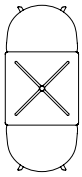

NEU TABLE / Ø70 CM

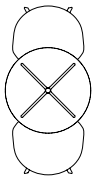

SEATING OVERVIEW / TILT TOP TABLE

The table drawings below are shown with About A Chair with arm (width 59 cm)

TILT TOP TABLE / Ø90 CM

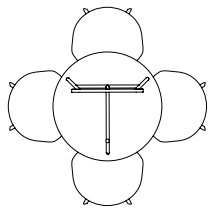

SEATING OVERVIEW / PALISSADE

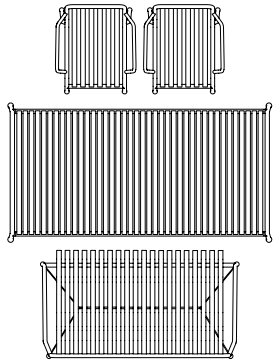

2 X DINING ARMCHAIR
1 X TABLE L170 X W90 CM
1 X DINING BENCH

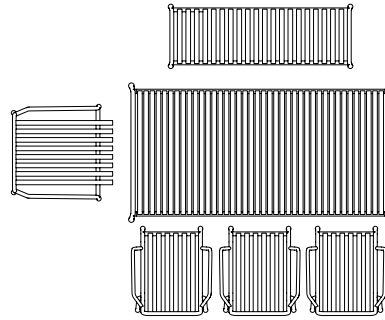

1 X TABLE L170 X W90 CM
1 X DINING BENCH
1 X DINING ARMCHAIR
3 X ARM CHAIR

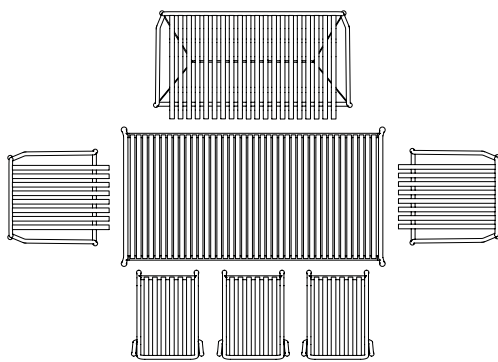

1 X TABLE L170 X W90 CM
1 X DINING BENCH
2 X DINING ARMCHAIR
3 X CHAIR

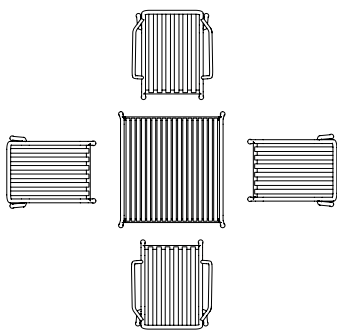

1 X TABLE L82,5 X W90 CM
2 X CHAIR
2 X ARM CHAIR

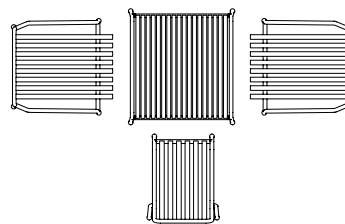

1 X TABLE L82,5 X W90 CM
2 X DINING ARMCHAIR
1 X CHAIR

SEATING OVERVIEW / NEW ORDER TABLE

The table drawing below are shown with About A Chair with arm (width 59 cm).

NEW ORDER TABLE / L100 X W100 CM

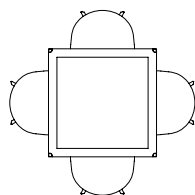

NEW ORDER TABLE / L150 X W75 CM

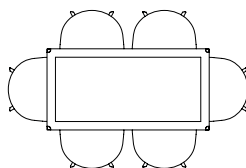

NEW ORDER TABLE / L150 X W100 CM

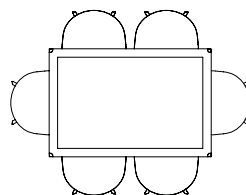

NEW ORDER TABLE / L150 X W150 CM

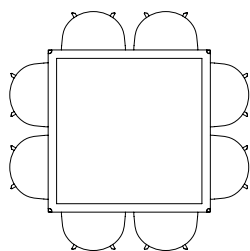

NEW ORDER TABLE / L200 X W100 CM

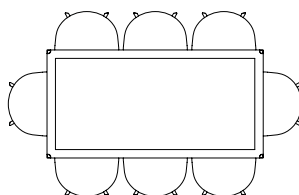

NEW ORDER TABLE / L200 X W150 CM

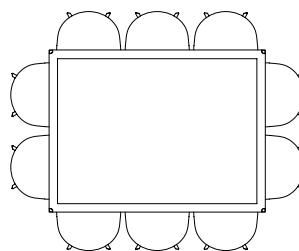

NEW ORDER TABLE / L250 X W100 CM

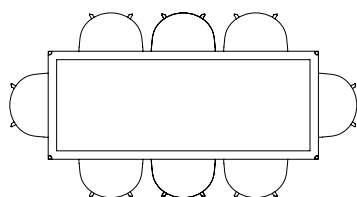

NEW ORDER TABLE / L300 X W100 CM

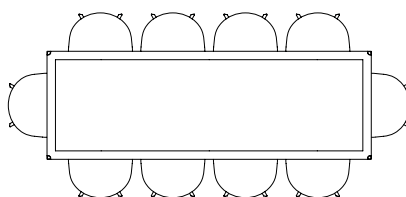

SOFT EDGE HANG UP BRACKET / GENERIC TABLES

For tables with stretchers along the tabletop edge, Soft Edge Hang Up high should be used.

The bracket fits for stretcher height from 0 – 40 mm. We recommend a 60 mm distance between each bracket.

EXAMPLE L200 X W90 CM

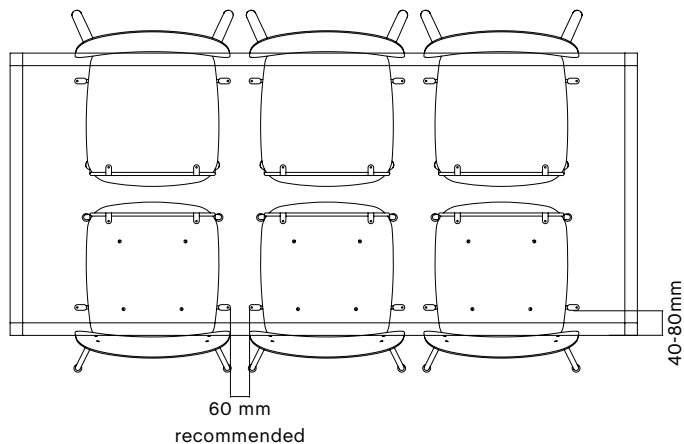

For tables with center stretcher, Soft Edge Hang Up Bracket low should be used. We recommend a 60 mm distance between each bracket.

Please use suitable screws for table top. We recommend Ø4,5 x (length according to tabletop thickness)

EXAMPLE L200 X W90 CM

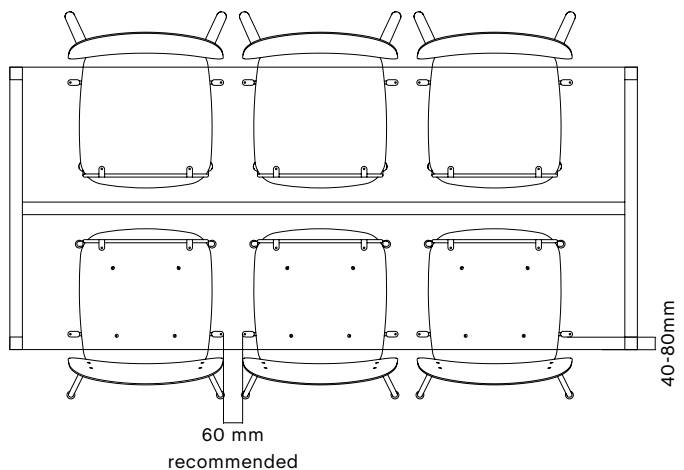

SOFT EDGE HANG UP BRACKET / CPH

The table drawings below are shown with Soft Edge chairs and Soft Edge Hang Up Bracket low.

We recommend a 60 mm distance between each bracket.

We recommend to use a 4,5 x 15 mm universal panhead screw for mounting.

CPH10 / L160 X D80 CM

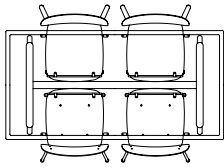

CPH30 / L200 X W90 CM

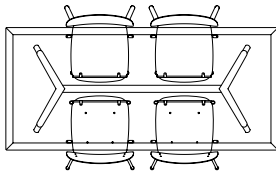

CPH30 / L250 X W90 CM

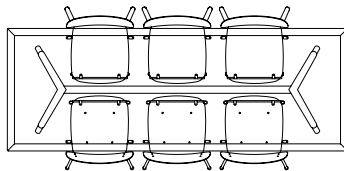

CPH30 / L300 X W90 CM

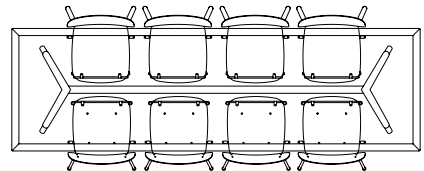

CPH30 / L250 X W120 CM

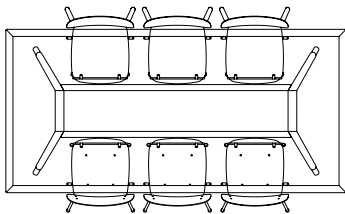

CPH30 / L300 X W120 CM

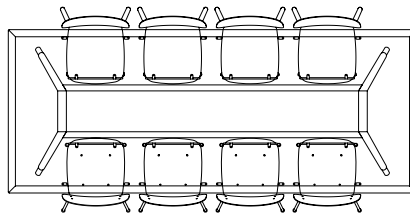

CPH90 / L130 X W65 CM

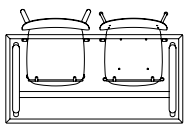

CPH190 / L150 X W70 CM

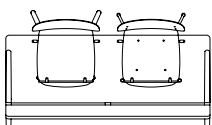

SOFT EDGE HANG UP BRACKET / AAT

The table drawings below are shown with Soft Edge chairs and Soft Edge Hang Up Bracket low.

We recommend a 60 mm distance between each bracket.

We recommend to use a 4,5 x 15 mm universal panhead screw for mounting.

AAT10 / L160 X D80 CM

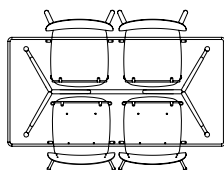

AAT10 / L180 X W90 CM

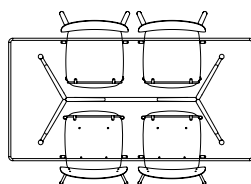

AAT10 / L220 X W90 CM

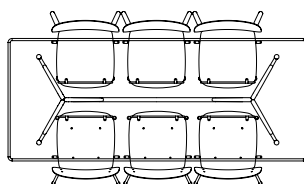

AAT10 / L280 X W90 CM

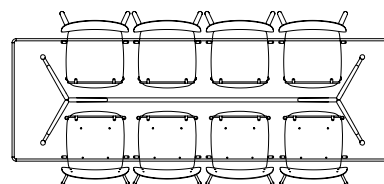

AAT10 / L180 X W105 CM

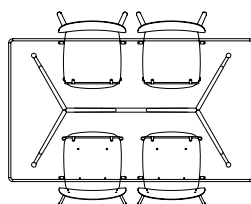

AAT10 / L220 X W105 CM

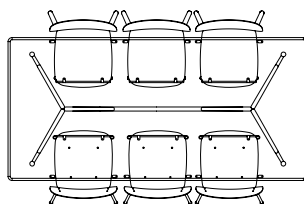

AAT10 / L280 X W105 CM

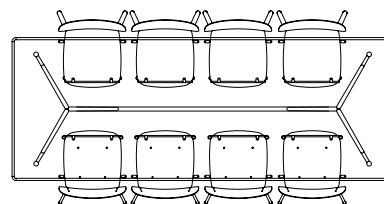

SOFT EDGE HANG UP BRACKET / T12

The table drawings below are shown with Soft Edge chairs and Soft Edge Hang Up High.

We recommend a 60 mm distance between each bracket.

We recommend to use a 4,5 x 15 mm universal panhead screw for mounting.

T12 / L160 X D80 CM

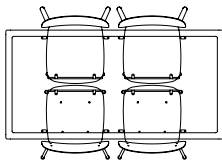

T12 / L200 X W95 CM

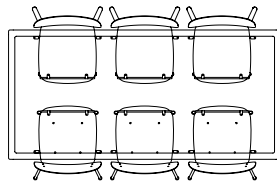

T12 / L250 X W95 CM

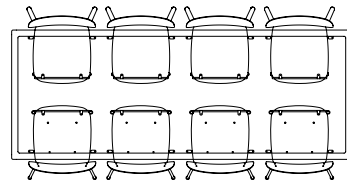

T12 / L320 X W95 CM

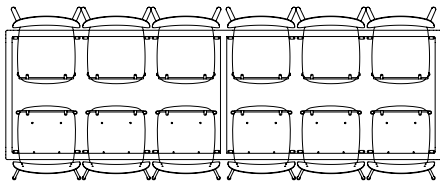

T12 / L400 X W95 CM

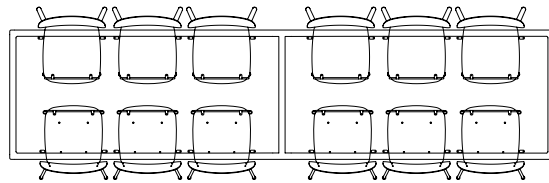

T12 / L200 X W120 CM

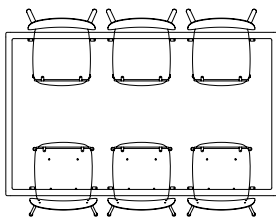

T12 / L250 X W120 CM

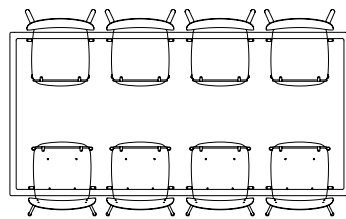

T12 / L320 X W120 CM

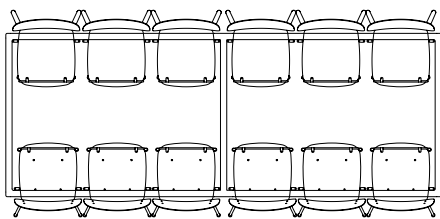

T12 / L400 X W120 CM

