

TEMO

DESIGN KRESSEL + SCHELLE



casala®

KRESSEL + SCHELLE

Jonas Kressel and Ivo Schelle studied Industrial Design in Kiel, Germany. In 1992 they started their own design agency in Hamburg and won several design awards ever since. Functionality and detail is key focus during their design process.

DESIGN LINKED TO FUNCTIONALITY

Casala specialises in the production of stylish contract furniture that excels in both design and functionality. "Design linked to Functionality" is deeply rooted within the DNA of our organisation and plays a major role in the design process. We work together with leading designers in our industry. A hundred years of experience in the furniture industry guarantees that Casala furniture also offers a lot of comfort and ease of use in addition to high quality.



NL

Jonas Kressel en Ivo Schelle studeerden Industrial Design in Kiel, Duitsland. In 1992 startten zij hun eigen ontwerp bureau in Hamburg en hebben sindsdien verschillende design awards gewonnen. Functionaliteit en detail staan centraal tijdens hun ontwerpproces.

DE

Jonas Kressel und Ivo Schelle studierten Industrial Design in Kiel und gründeten 1992 ihr Designbüro in Hamburg. Seither gewannen sie mehrere Designpreise. Funktionalität und Detail ist der Schwerpunkt während des Designprozesses.

FR

Jonas Kressel et Ivo Schelle ont étudié le design industriel à Kiel, en Allemagne. En 1992, ils ont commencé leur propre agence de design à Hambourg et ont remporté plusieurs prix de design depuis. La fonctionnalité et les détails sont essentiels au cours de leur processus de conception.

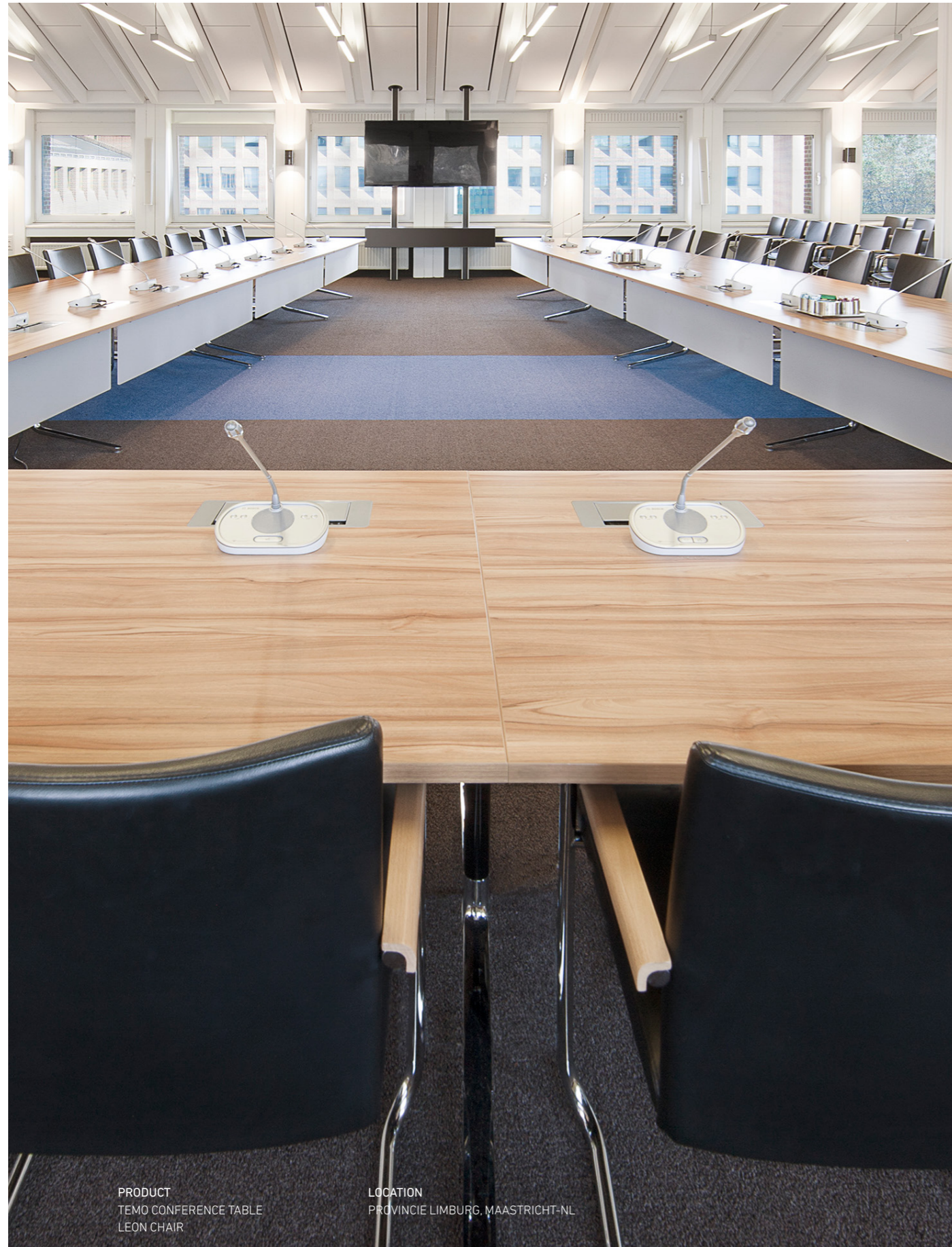

PRODUCT
TEMO CONFERENCE TABLE
LEON CHAIR

LOCATION
PROVINCIE LIMBURG, MAASTRICHT-NL

TEMO

At first glance you do not see the wide range of possibilities. But its durable material, the design and the craftsmanship with which Temo is manufactured gives it that little bit extra. Temo is a stylish conference table which stands out from the crowd, and the well-thought-out configurations rises above the average. Temo has a wide variety of shapes and sizes. From conference table to fliptop table and from high table to coffee table.

NL
Op het eerste gezicht zie je de uitgebreide mogelijkheden van Temo er niet aan af. Maar het duurzame materiaal, het design en het vakmanschap waarmee Temo is vervaardigd, geven hem net dat beetje extra. Hierdoor onderscheidt zijn chique conferentietafel zich van de middelmaat en ontstaat zijn doordachte conferentieopstelling de doorsnee vergadertafel. Temo kent een grote verscheidenheid aan vormen en varianten. Van vergadertafel tot (mobiele) fliptop tafel en van sta- tot loungetafel.

DE
Auf den ersten Blick sieht man Temo die umfangreichen Möglichkeiten gar nicht an, aber das sehr langlebige Material, das Design und fachmännische Verarbeitung gibt Temo das gewisse extra. Hierdurch unterscheidet sich der gelungene Konferenztisch vom Mittelmaß. Die durchdachten Möglichkeiten für Konferenzaufstellungen übertreffen bei weitem den Durchschnitt von üblichen Konferenztischen. Temo bietet eine sehr große Vielzahl an Formen und Varianten. Vom Konferenztisch über Versammlungstisch bis zum mobilen fliptop Tisch und Stehtischen.

FR
Les infinies possibilités de Temo ne se devinent pas au premier coup d'œil. Pourtant, l'utilisation de matériaux durables, le design et le savoir-faire avec lesquels Temo est fabriquée lui donnent ce quelque chose en plus. C'est ce qui permet à cette élégante table de réunion de sortir du lot et qui distingue les différentes configurations pour conférences, parfaitement pensées, des autres produits existants. La gamme Temo a une grande variété de formes et de finitions, de la table de conférence à la table abat-joint en passant par des mange-debout et des tables basses.

FREEDOM OF SHAPE & STYLE



With Temo, large table configurations in any desirable shape can easily be created. Its table tops can be placed into a suitable combination for every imaginable space with the aid of an adjustable connection element in the frame. Temo combines ultimate style stability with great freedom of shape and style.

NL
Met Temo kunnen ook grote opstellingen met bijzondere vormen gemakkelijk worden samengesteld. Zijn tafelbladen kunnen met behulp van een instelbaar verbindingselement in het frame tot een passende combinatie voor elke denkbare ruimte geplaatst worden. Temo koppelt ultieme stijlvastheid aan een grote vrijheid van vorm.

DE
Mit Temo sind auch große Tischaufstellungen mit besonderen Plattenformen möglich. Die Tischgestelle können mit Hilfe des einstellbaren Verbindungselementes in fast jedem Winkel aufgestellt werden. So sind viele Kombinationen für jede nur denkbare Tischaufstellung möglich. Temo kombiniert ultimative Stilsicherheit mit einer großen Formfreiheit.

FR
Avec Temo, de larges configurations de tables peuvent être réalisées dans toutes les formes souhaitées. Ses plateaux sont aisément assemblables pour créer une configuration adaptée à n'importe quel espace, grâce à un système de connexion modulable. Temo associe la perfection du style à une grande liberté de formes.



CONFIGURATIONS

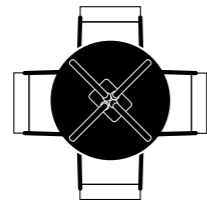

Ø 100 CM 4h

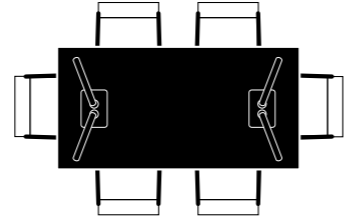

100 x 200 CM 6h

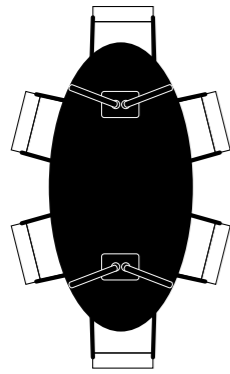

120 x 240 CM 6h

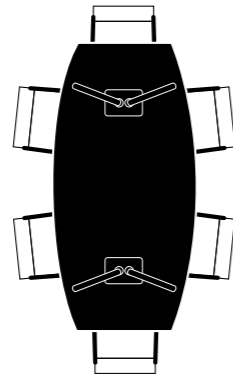

120 x 240 CM 6-8h

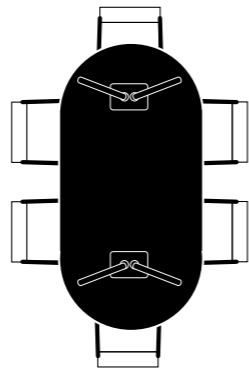

120 x 240 CM 6-8h

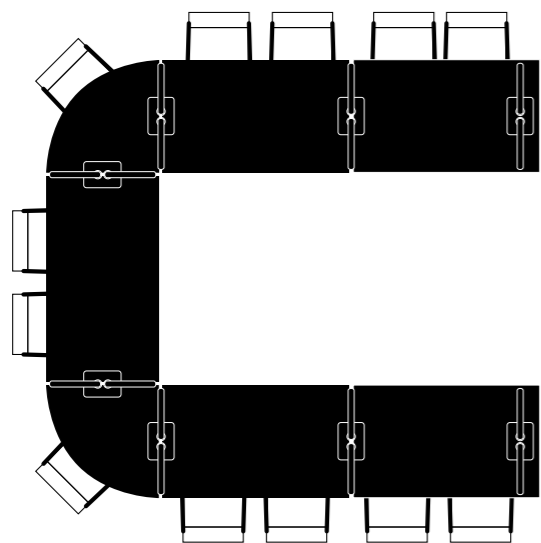

470 x 400 CM 12h

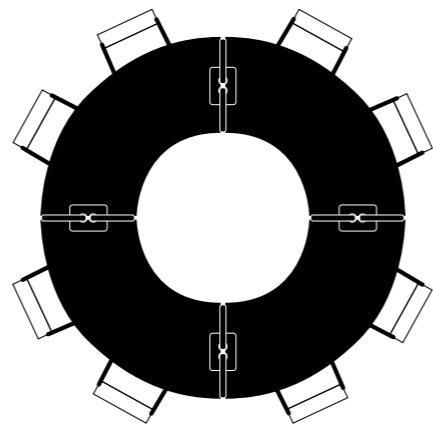

Ø 300 CM 8h

CONFIGURATIONS

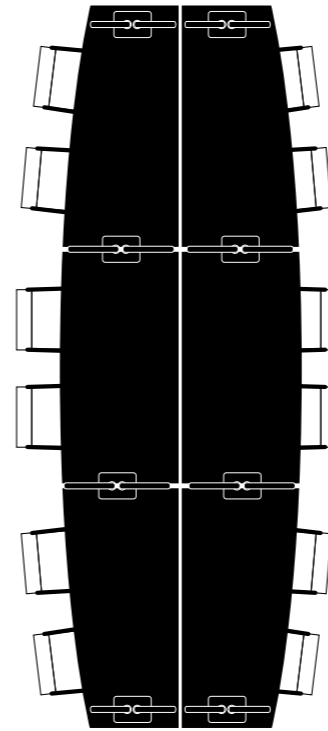

200 x 600 CM 12-18h

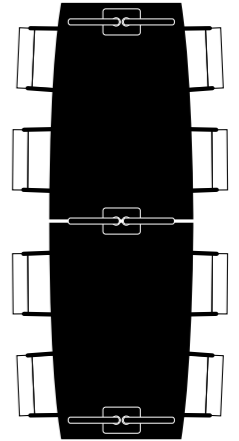

120 x 360 CM 8-12h

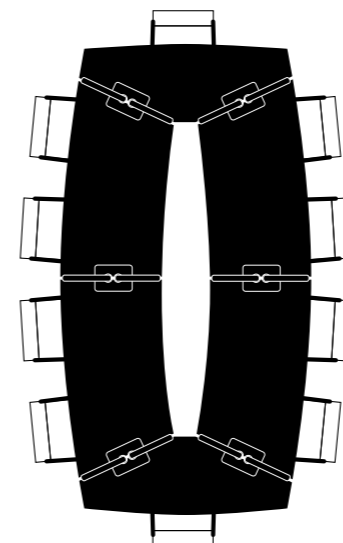

222 x 418 CM 12-16h

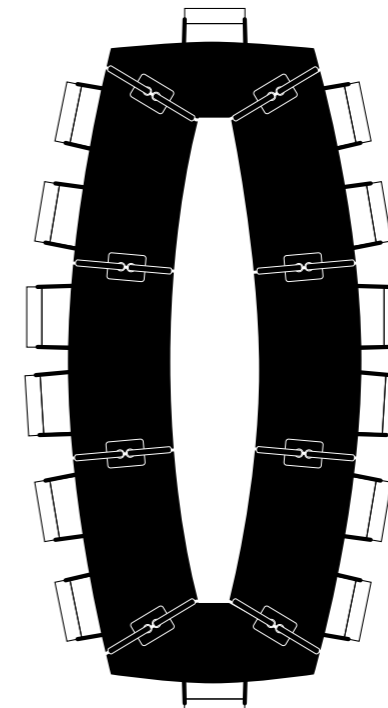

267 x 578 CM 16-22h

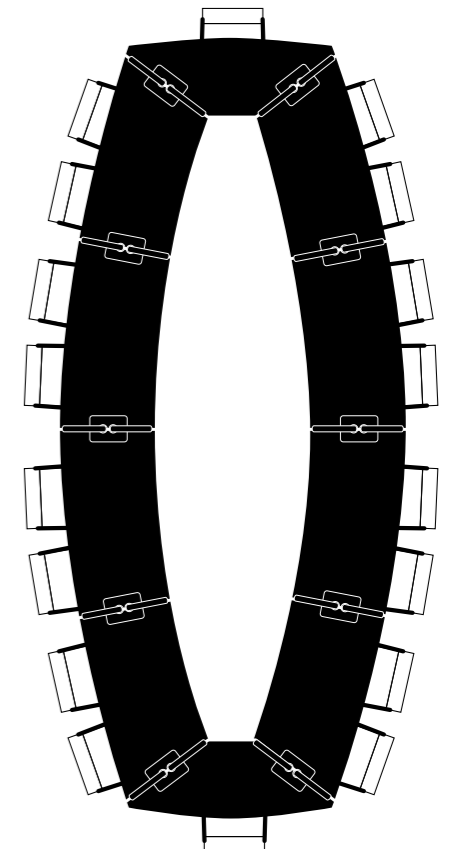

327 x 736 CM 20-30h

TEMO FLIPTOP: A SMART MOVE

linking system

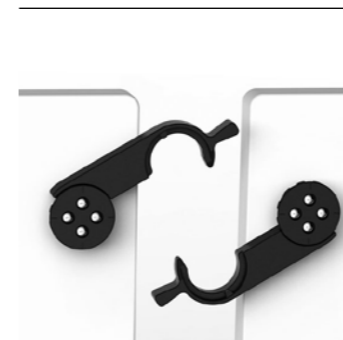

castors



bridging top

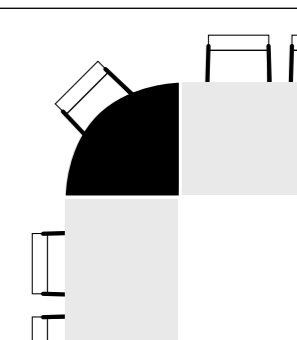

Thanks to its castors and its foldable table top, Temo Fliptop can easily be placed in various temporary setups. Temo Fliptop is equipped with a safety mechanism, this prevents the table top from unexpectedly unfolding. As a result the tables can be transported and stored safely, quickly and efficiently.

NL
Door zijn wieltjes en het opklapbare tafelblad is Temo Fliptop eenvoudig in verschillende tijdelijke opstellingen te plaatsen. Temo Fliptop is voorzien van een veiligheidsmechanisme, dit voorkomt dat het tafelblad ongewenst uitklapt. Hierdoor kunnen de tafels veilig, snel en efficiënt worden getransporteerd en opgeslagen.

DE
Dank seiner Rollen und der hochklappbaren Tischplatte ist Temo einfach in unterschiedlichen Kombinationen aufstellbar. Temo Fliptop ist ausgestattet mit einer Sicherheitsmechanik. Diese verhindert dass die Tischplatte ungewollt ausklappt. Hierdurch können die Tische schnell, sicher und effizient transportiert und aufgestellt werden.

FR
Grâce à ses roues et son plateau rabattable, Temo Fliptop peut être facilement installée dans différentes configurations éphémères. Temo Fliptop est équipée d'un mécanisme de sécurité qui empêche le plateau de basculer inopportunément. Les tables peuvent ainsi être déplacées et rangées sans danger, rapidement et efficacement.



→ BRAKES



CASALA TEMO TABLE

CASALA TEMO TABLE

PRODUCT
 TEMO FLIPTOP TABLE
 AXA FOLDING CHAIR

LOCATION
 DUKDALF, LELYSTAD-NL



CASALA TEMO TABLE

CASALA TEMO TABLE

PRODUCT
TEMO CONFERENCE TABLE
LEON IV CHAIR

HIGH TABLE & COFFEE TABLE



A small coffee table or stylish high table, this is also possible within the Temo table program. These models are available with a 3 and 4-foot base. The high tables can be folded up and stored nested.

NL
Een kleine loungetafel of stijlvolle stafel, ook dit is mogelijk binnen het Temo tafelprogramma. Deze modellen zijn leverbaar in een 3 en 4-teens onderstel. De statafels kunnen opgeklapt en genest opgeborgen worden.

DE
Kleiner Loungetisch oder stilvoller Stehtisch, auch das ist möglich innerhalb des Temo Tischprogramm. Diese Modelle sind lieferbar mit 3-Fuß oder 4-Fuß Untergestell. Die Stehtische können aufgeklappt oder gestaffelt eingelagert werden.





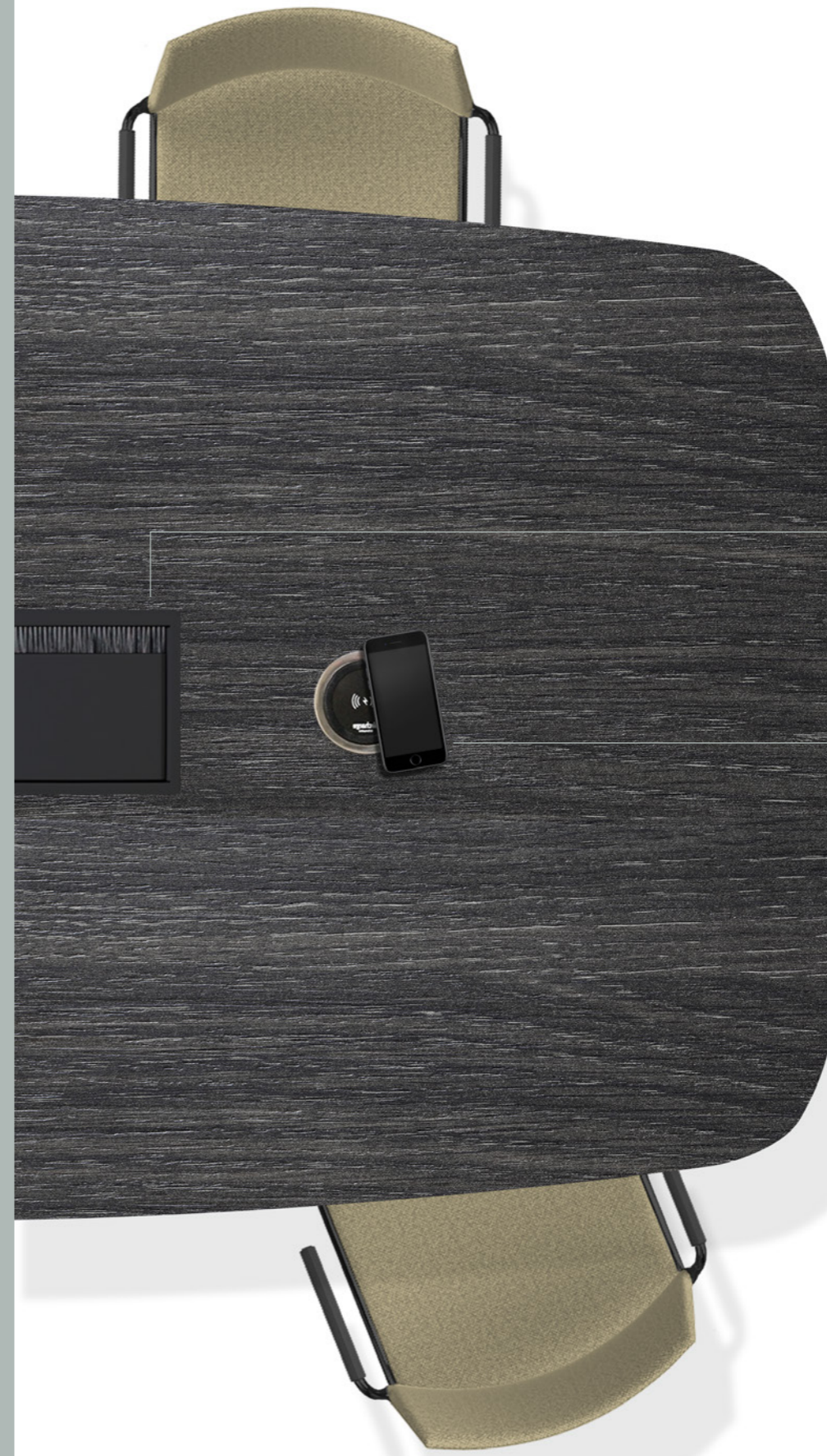

FR
Une petite table basse ou un élégant mange-debout, c'est également possible avec la gamme de table Temo. Ces modèles sont disponibles avec un piètement 3 ou 4 branches. Les mange-debout peuvent être repliés afin d'optimiser le stockage.



CONFERENCES
ARE MULTI-
MEDIA EVENTS
NOWADAYS,
FREQUENTLY
SUPPORTED BY
MEANS OF
LAPTOPS,
PROJECTION
AND SOUND
EQUIPMENT.



CABLE PORT OPTIONS

-  AUDIO
-  LAN
-  EXTERNAL DISPLAY
-  USB
-  VIDEO
-  POWER SUPPLY

WIRELESS CHARGING

CASALA TEMO TABLE

CASALA TEMO TABLE

REFERENCE

Temo coffee table & Parker IV armchair / Automatic Signal, Rijsenhout - NL



REFERENCE

Temo high table & Ravelle I barstool



Temo table & Onyx III chair



Temo table & Leon chair



CASALA TEMO TABLE

CASALA TEMO TABLE

CONFERENCING IN ANY DESIRABLE SETTING

Today conferences are multimedia events where tablets, laptops, projection and sound installations are often used. For this Temo can be used separately or in configuration. Temo is fully in line with modern needs and can be equipped with, among other things, ethernet ports, power supply and even with screens mounted in the table. Systems from various suppliers can be integrated into our tables.

NL

Conferenties zijn tegenwoordig multimediacongressen waar vaak tablets, laptops, projectie en geluidsinstallaties worden gebruikt. Hiervoor kan Temo separaat of in configuratie worden ingezet. Temo sluit helemaal aan op de moderne behoeften en is te voorzien van onder andere ethernetpoorten, stroomvoorziening en zelfs met in de tafel gemonteerde schermen. In onze tafels kunnen systemen van uiteenlopende leveranciers worden geïntegreerd.

DE

Konferenzen sind heutzutage Multimediakongresse wo Tablets, Laptops, Projektoren und Schallschutzinstallationen eingesetzt werden. Hierfür kann Temo separat ausgestattet oder genutzt werden. Temo erfüllt die Anforderungen an moderne Ausstattungen und kann u.a. bestückt werden mit Internetzugang, Stromanschluß und sogar mit in die Platte integrierten Bildschirmen. In unsere Tische können dafür Systeme verschiedener Hersteller integriert werden.

FR

Aujourd'hui les conférences sont des événements multimédias où les tablettes, les ordinateurs, la vidéo-projection et les systèmes audio sont très souvent souhaités. C'est pourquoi Temo peut être utilisée seule ou en configuration. Temo est parfaitement en ligne avec les besoins actuels et peut être équipée, entre autres, de port Ethernet, d'électrification et même d'écran monté sur la table. Les systèmes de nombreux fabricants peuvent être intégrés à nos tables.

power frame

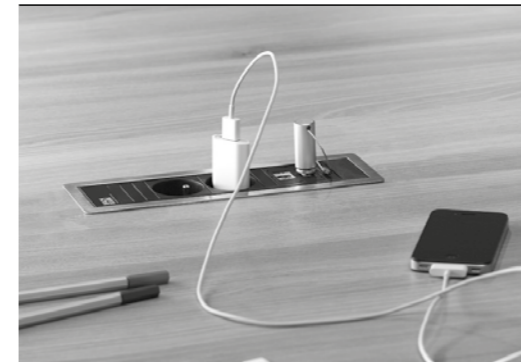

coni

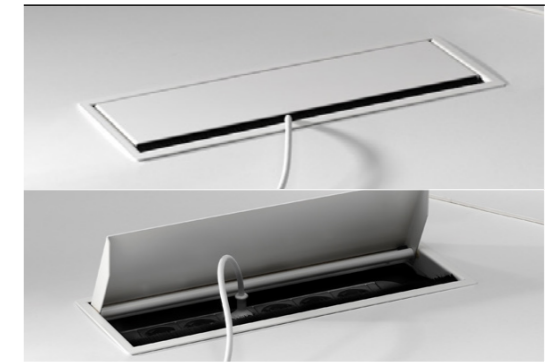

pix - custom module





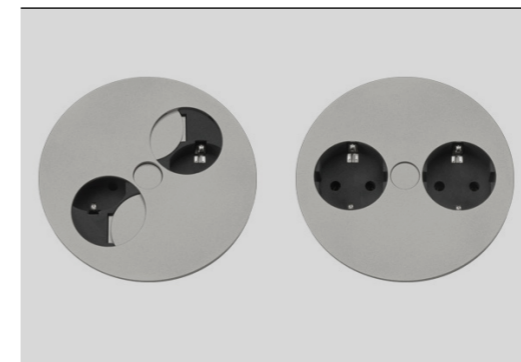



twist box

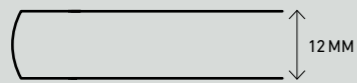

wireless charging station



table tops & edges

<p>Edge A</p>  <p>Core: 12 mm SCL Finish: standard white Edge: SCL edge round shaped (black)</p>	<p>Edge F</p>  <p>Core: 25 mm plywood Finish: 0,9 mm HPL in standard colours Edge: plywood bevel shaped</p>
<p>Edge CS</p>  <p>Core: 22 mm chipboard Finish: 0,9 mm HPL on both sides in standard colours Edge: 2 mm ABS with impact buffer, in standard colours or plywood look</p>	<p>Edge H</p>  <p>Core: 25 mm MDF Finish: 0,9 mm HPL in standard colours Edge: 2 mm ABS in standard colours or plywood look</p>
<p>Edge C</p>  <p>Core: 22 mm chipboard Finish: 0,9 mm HPL on both sides in standard colours Edge: 2 mm ABS with impact buffer, in standard colours or plywood look</p> <p>*27mm HPL on one side</p>	<p>Edge C</p>  <p>Core: 18 mm chipboard Finish: 0,4 mm melamine in standard colours Edge: 2 mm ABS in standard colours or plywood look</p>

powder coatings



modesty panel



linking system

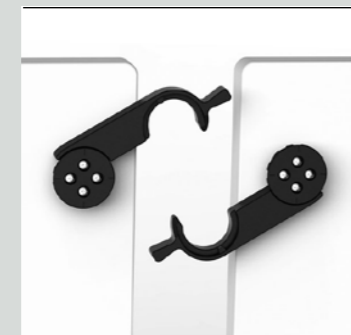

electrification



finishes

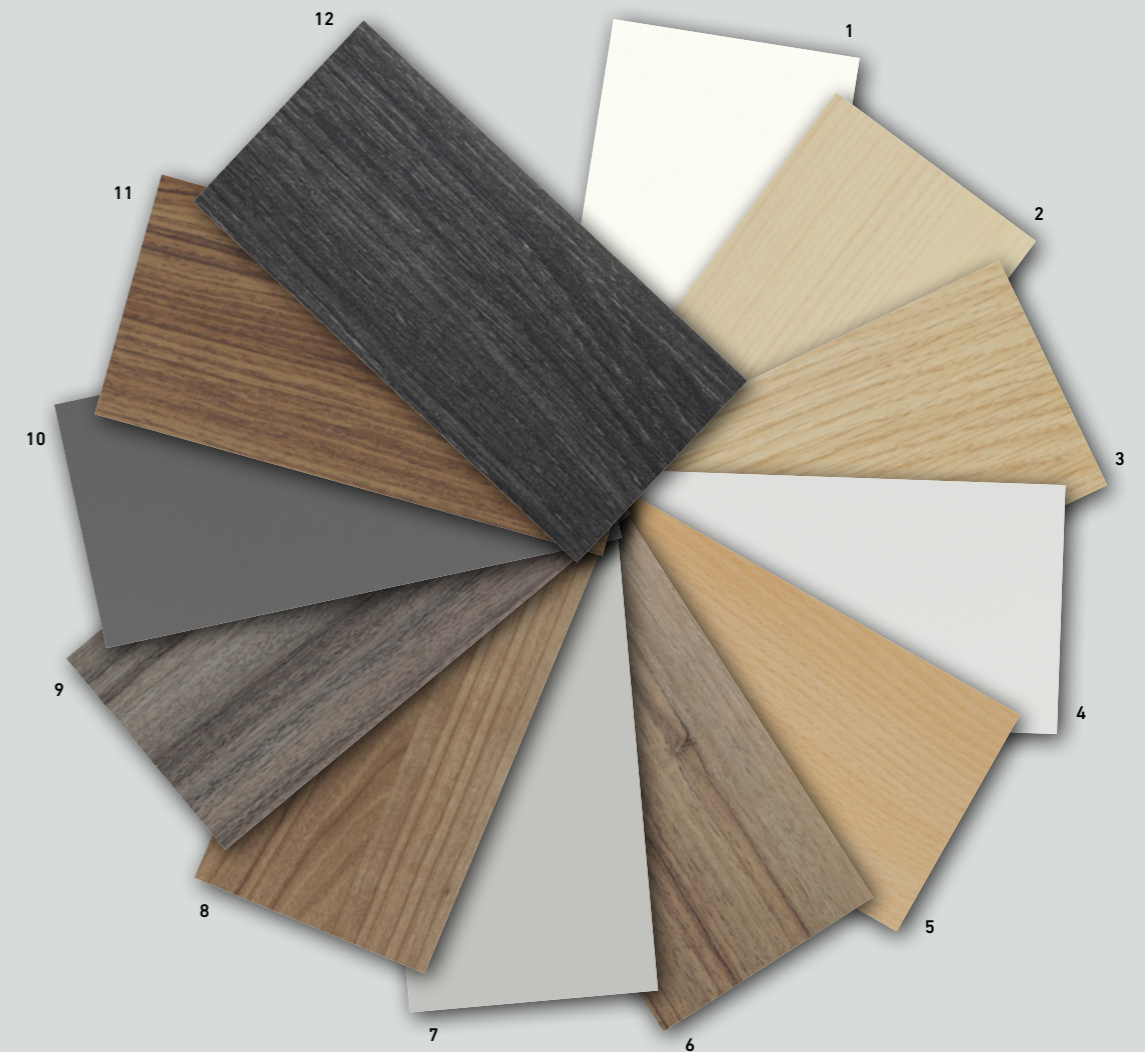

All table-tops are available in HPL & Melamine and do have a matching stain, excluding Lindberg oak and Madison Walnut.

- | | | | |
|--|--|---|--|
| <p>1 White U1026*
Structure: VV
Brand: Pfeiderer
Reflection value: 0,82
Matching Laser edge</p> | <p>4 Grey U035
Structure: VV
Brand: Pfeiderer
Reflection value: 0,73
Matching Laser edge</p> | <p>7 Light grey U1188
Structure: VV
Brand: Pfeiderer
Reflection value: 0,58
Matching Laser edge</p> | <p>10 Anthracite U1290
Structure: VV
Brand: Pfeiderer
Reflection value: 0,16
Matching Laser edge</p> |
| <p>2 Light maple F04/054
Structure: VV
Brand: Pfeiderer
Reflection value: 0,61
Matching Laser edge</p> | <p>5 White beech R5320
Structure: VV
Brand: Pfeiderer
Reflection value: 0,42
Matching Laser edge</p> | <p>8 Havana cherry R5681
Structure: VV
Brand: Pfeiderer
Reflection value: 0,30
Matching Laser edge</p> | <p>11 Standard walnut R4801
Structure: VV
Brand: Pfeiderer
Reflection value: 0,48
Matching Laser edge</p> |
| <p>3 Lindberg oak R4223**
Structure: MO
Brand: Pfeiderer
Reflection value: 0,45
Matching Laser edge Pearl</p> | <p>6 Madison walnut R4816**
Structure: MO
Brand: Pfeiderer
Reflection value: 0,23
Matching Laser edge</p> | <p>9 Milano walnut R4896
Structure: MO
Brand: Pfeiderer
Reflection value: 0,16
Matching Laser edge</p> | <p>12 Dark mountain oak R4371
Structure: MO
Brand: Pfeiderer
Reflection value: 0,10
Matching Laser edge</p> |

*Also available in SCL
**No matching stain available.

SHAPES & LEGS

standard



	120* x 60/70/80 140* x 60/70/80 160 x 60/70/80 180 x 60/70/80 200 x 80/90/100/120 240 x 80/90/100/120		280 x 120 360 x 120 400 x 120 480 x 120
--	--	--	--

*only for T-leg

	180 x 100 200 x 100 240 x 120		280 x 120 360 x 120
--	-------------------------------------	--	------------------------

	180 x 100 x 80 200 x 100 x 80 240 x 120 x 100		280 x 120 x 100 360 x 120 x 100 400 x 120 x 100 480 x 120 x 100
--	---	--	--

	180 x 100 200 x 100 240 x 120		280 x 120 x 100 360 x 120 x 100 400 x 120 x 100 480 x 120 x 100
--	-------------------------------------	--	--

bridging top

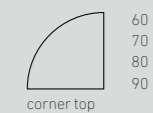

fliptop



	120* x 60/70/80 140 x 60/70/80 150 x 75 160 x 60/70/80 180 x 70/80/90 200 x 80/100		
--	---	--	--

*only for T-leg

	160 x 80		
	160 x 80*		

*only for T-leg

	180 x 100 x 80 200 x 100 x 80		
--	----------------------------------	--	--

	180 x 100 200 x 100		
--	------------------------	--	--

coffee tables 45cm



	ø 60 / ø 70 / ø 80 / 90 / 100 / 110 / 120		60 x 60 70 x 70 80 x 80 90 x 90
--	---	--	--

round and square 74 cm

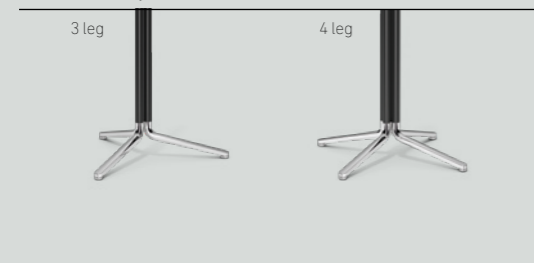

	ø 60 / 70 / 80 / 90 / 100 / 110 / 120		60 x 60 70 x 70 80 x 80 90 x 90
--	---------------------------------------	--	--

high tables 110cm



	ø 60 / ø 70 / ø 80 / 90 / 100 / 110 / 120		60 x 60 70 x 70 80 x 80 90 x 90
--	---	--	--

High table 3-leg available as Fliptop

Distance between table feet available in 60, 70, 80 and 90 cm (all models)
Recommended chairs: Parker, Leon, Keep Moving, Feniks

CASALA.01/2019 V4

SHOWROOMS

Casala Meubelen Nederland bv
Rolweg 10
4104 AV Culemborg
The Netherlands
+31 (0)345 51 73 88
info@casala.com

Palau
Cruquiusweg 111m
1019 AG Amsterdam
The Netherlands
+31 (0)20 463 39 80
info@palau.nl

Casala Objektmöbel GmbH
Magirusstraße 16
31867 Lauenau
Germany
+49 (0)5043 71 0
casala@casala.com

Casala Ltd
2 Sycamore Street
Clerkenwell, EC1Y 0SF
London
United Kingdom
+44 (0)20 3958 0058
sales@casala.com

Casala S.à.r.l.
54 rue du 19 Janvier
92380 Garches
France
+33 (0)1 47 10 02 22
contact@casala.com

www.casala.com

© Photography
Alexander berge: 14
Chris van Koeverden: 4, 12, 19

© Casala Meubelen Nederland B.V.
All copyrights and intellectual property rights in this publication are the property of Casala. No part of this item may be reproduced without the prior written permission of Casala. We respect the rights of third parties. If material has been produced without recognition, please inform us at marketing@casala.com.

The colours in this publication may differ to the original product. We recommend requesting a product sample. Sample service and further information:

www.casala.com/samples

casala®

